

## SCREW/VVS

VITE ALTA PRESSIONE/ACCIAIO  
HIGH PRESSURE SCREW COUPLINGS/STEEL  
HOCHDRUCKSCHRAUBKUPPLUNGEN/STAHL  
COUPLEURS A VISSEER HAUTES PRESSION/ACIER

### Caratteristiche tecniche

- Intercambiabilità: Faster VVS
- Occlusione: valvola
- Aggancio: a vite
- Materiale: acciaio
- Finitura: Zn-Fe (Cr III)
- Filettature: BSP - NPT
- Guarnizioni standard: NBR
- Temperatura d'esercizio: -25 °C +100 °C
- Guarnizioni opzionali: FKM, EPDM o altro
- Pressioni di esercizio: 210-650 bar
- Connessione in pressione: consentita (lato maschio o lato femmina)

Nominal size				Max working pressure MPa	Rated flow l/min	Max flow rate l/min	Min burst pressure			Fluid spillage cc
DNP	BG	ISO	mm				Male	Female	Coupled	
10	2	10	6,2	65	18	18	300	300	300	1,9
13	3	12.5	9	60	23	23	250	270	220	2,7
20	4	19	11	50	45	45	240	260	210	9,3
25	5	25	13,3	46	106	106	230	260	200	16
30	6	31.5	22,2	36	189	189	150	150	150	30
39	7	40	24,6	36	300	300	120	150	150	54
50	8	50	30	21	757	757	130	130	105	120

1 MPa = 145,04 psi • 1 l = 0,264 gal

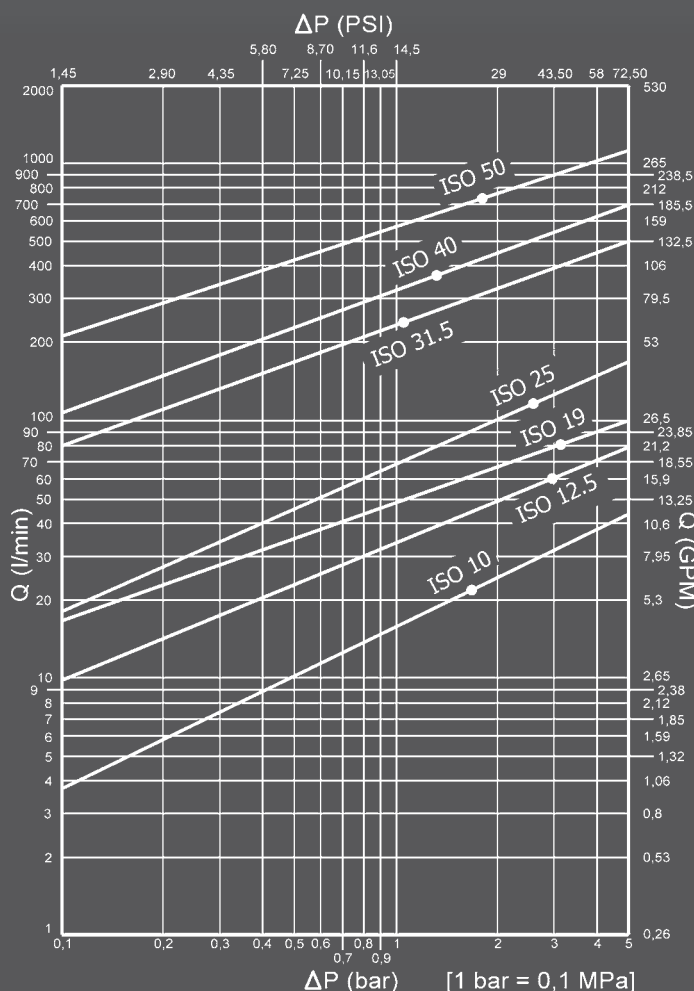

### Technical data

- Interchange: VVS Faster
- Occlusion: poppet
- Locking: screw
- Material: steel
- Finishing: Zn-Fe (Cr III)
- Threads: BSP - NPT
- Standard seals: NBR
- Working temperature: -25 °C +100 °C
- Optional seals: FKM, EPDM or more
- Working pressure: 210-650 bar
- Connection under pressure: allowed (both male or female side)

### Technische Merkmale

- Austauschbarkeit: VVS Faster
- Verschluss: ventil
- Kupplung: Schraubweise
- Werkstoff: Stahl
- Ausführung: Zn-Fe (Cr III)
- Gewinde: BSP - NPT
- Standard-Dichtungen: NBR
- Betriebstemperatur: -25 °C +200 °C
- Dichtungen nach Wahl: FKM, EPDM, usw.
- Betriebsdruck: 210-650 bar
- Kuppeln unter Druck: erlaubt (Steckerseite oder Muffenseite)

### Caracteristiques techniques

- Intercambiabilidad: VVS Faster
- Obturación: clapet
- Acrochaje: a vissé
- Matériel: acier
- Traitement: Zn-Fe (Cr III)
- Taraudage: BSP - NPT
- Joints standard: NBR
- Température de service: -25 °C +100 °C
- Joints facultatifs: FKM, EPDM, ect.
- Pression de service: 210-650 bar
- Connexion sous pression: possible (côté male ou femelle)

**VW1 DN10 - BG 2 - ISO 10**

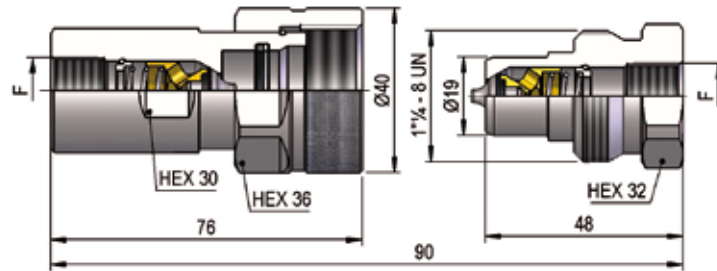

F	STANDARD	FEMMINA - FEMALE - MUFFE - FEMELLE			MASCHIO - MALE - STECKER - MALE		
		COD. F	Weight (g)	Packaging (pcs.)	COD. M	Weight (g)	Packaging (pcs.)
BSP 3/8"	DIN 3852-2-X	VW1.1010.002	344	24	VW1.1010.003	155	42
NPT 3/8"	ANSI B1.20.3	VW1.1010.012	346	24	VW1.1010.013	157	42

**VW1 DN13 - BG 3 - ISO 12.5**

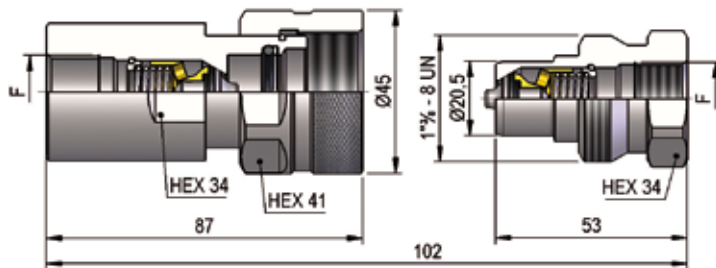

F	STANDARD	FEMMINA - FEMALE - MUFFE - FEMELLE			MASCHIO - MALE - STECKER - MALE		
		COD. F	Weight (g)	Packaging (pcs.)	COD. M	Weight (g)	Packaging (pcs.)
BSP 1/2"	DIN 3852-2-X	VW1.1313.002	576	20	VW1.1313.003	177	35
NPT 1/2"	ANSI B1.20.3	VW1.1313.012	582	20	VW1.1313.013	180	35

**VW1 DN20 - BG 4 - ISO 19**

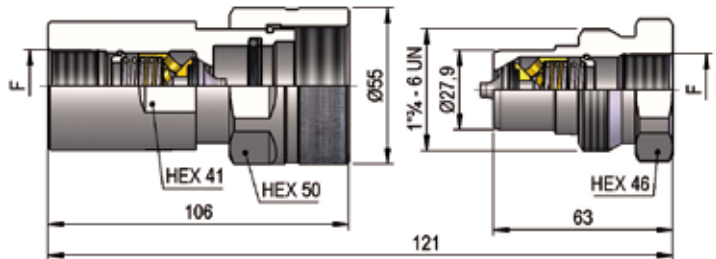

F	STANDARD	FEMMINA - FEMALE - MUFFE - FEMELLE			MASCHIO - MALE - STECKER - MALE		
		COD. F	Weight (g)	Packaging (pcs.)	COD. M	Weight (g)	Packaging (pcs.)
BSP 3/4"	DIN 3852-2-X	VW1.2019.002	988	20	VW1.2019.003	364	24
NPT 3/4"	ANSI B1.20.3	VW1.2019.012	997	20	VW1.2019.013	373	24

**VW1 DN25 - BG 5 - ISO 25**

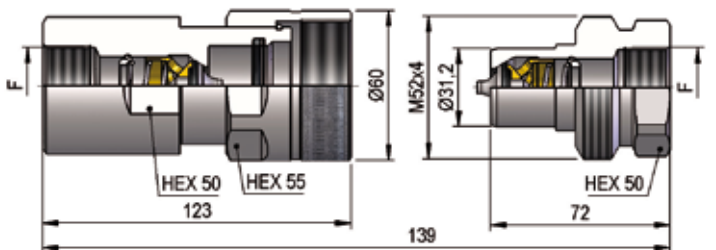

F	STANDARD	FEMMINA - FEMALE - MUFFE - FEMELLE			MASCHIO - MALE - STECKER - MALE		
		COD. F	Weight (g)	Packaging (pcs.)	COD. M	Weight (g)	Packaging (pcs.)
BSP 1"	DIN 3852-2-X	VW1.2525.002	1403	15	VW1.2525.003	532	18
NPT 1"	ANSI B1.20.3	VW1.2525.012	1481	15	VW1.2525.013	540	18

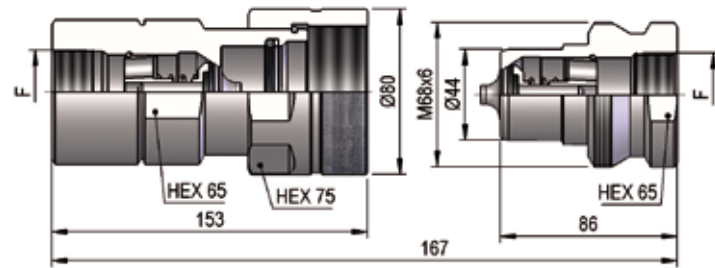
**VWV1 DN30 - BG 6 - ISO 31.5**

F	STANDARD	FEMMINA - FEMALE - MUFFE - FEMELLE			MASCHIO - MALE - STECKER - MALE		
		COD. F	Weight (g)	Packaging (pcs.)	COD. M	Weight (g)	Packaging (pcs.)
BSP 1"¼	DIN 3852-2-X	VWV1.3031.002	2870	8	VWV1.3031.003	1050	6
NPT 1"¼	ANSI B1.20.3	VWV1.3031.012	2950	8	VWV1.3031.013	1092	6

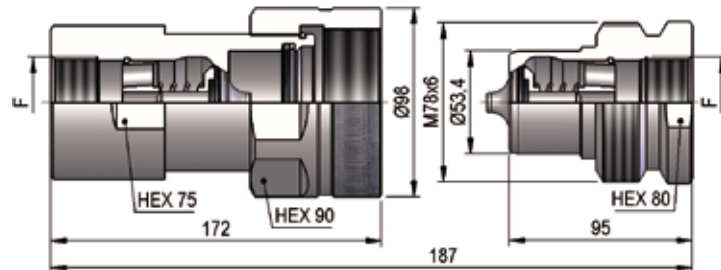
**VWV1 DN39 - BG 7 - ISO 40**

F	STANDARD	FEMMINA - FEMALE - MUFFE - FEMELLE			MASCHIO - MALE - STECKER - MALE		
		COD. F	Weight (g)	Packaging (pcs.)	COD. M	Weight (g)	Packaging (pcs.)
BSP 1"½	DIN 3852-2-X	VWV1.3939.002	4440	3	VWV1.3939.003	1700	8
NPT 1"½	ANSI B1.20.3	VWV1.3939.012	4470	3	VWV1.3939.013	1720	8

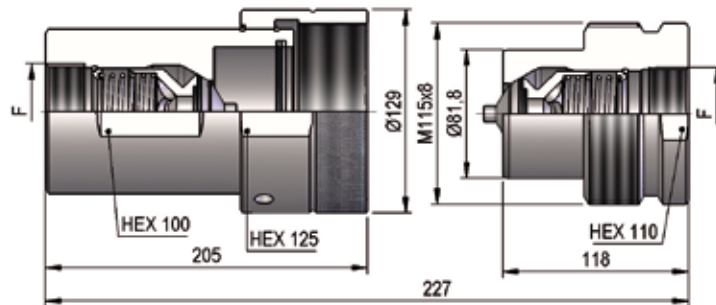
**VWV1 DN50 - BG 8 - ISO 50**

F	STANDARD	FEMMINA - FEMALE - MUFFE - FEMELLE			MASCHIO - MALE - STECKER - MALE		
		COD. F	Weight (g)	Packaging (pcs.)	COD. M	Weight (g)	Packaging (pcs.)
BSP 2"	DIN 3852-2-X	VWV1.5051.002	8670	2	VWV1.5051.003	4930	2
NPT 2"	ANSI B1.20.3	VWV1.5051.012	8920	2	VWV1.5051.013	5070	2

**METAL CAPS**

NOMINAL SIZE			FEMALE DUST PLUG				MALE DUST CAP				MATERIAL		
DNP	BG	ISO	COD. F	Dimensions			Weight	COD. M	Dimensions			Weight	
				D	L	D1	(g)		D	L	D1	(g)	
10	2	10	SVW.10202	34	240	30	71	SVW.10203	34	240	30	58	Aluminum
13	3	12.5	SVW.13202	34	240	30	83	SVW.13203	38	240	30	87	Aluminum
20	4	19	SVW.20202	53	300	48	194	SVW.20203	48	290	41	163	Aluminum
25	5	25	SVW.25202	53	290	41	301	SVW.25203	58	300	48	264	Aluminum
30	6	31.5	SVW.30202	71	400	48	448	SVW.30203	81	400	48	760	Aluminum
39	7	40	SVW.39202	98	210	46	420	SVW.39203	85	260	46	380	Aluminum
50	8	50	SVW.50202	115	270	46	1050	SVW.50203	100	300	46	1250	Aluminum

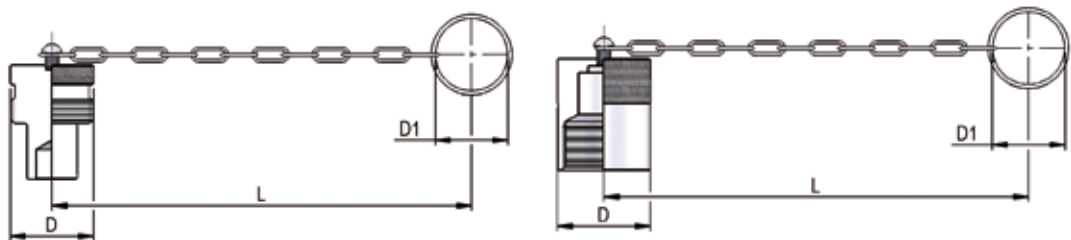

**SPARE PARTS**



NOMINAL SIZE			FEMALE GASKET	
DNP	BG	ISO	OR (NBR)	BK (PTFE)
10	2	10	PDV.010.120	PBV.010.130
13	3	12.5	PAV.013.120	VV.013.130
20	4	19	PAV.019.120	VV.019.130
25	5	25	PDV.025.120	PDV.025.130
30	6	31.5	PBV.039.120	VV.030.130
39	7	40	VV.039.120	VV.039.130
50	8	50	VV.050.120	VV.050.130